

dizzer[®] P

Ultrafiltration modules



dizzer® P - Ultrafiltration elements

- For small scale applications (e.g. Point-of-Use, Point-of-Entry)
- Easy installation, plug-and-play operation
- Excellent quality of filtrate
- Reliable rejection of microorganisms and viruses
- Low operating costs



4" UF modules with Multibore® 0.9 membrane

Module data			dizzer® P 4040-6.0		dizzer® P 4021-2.5	
Part number			VK-0049		VK-0048	
Membrane area	m ²	sq.ft.	6.0	65	2.5	27
Length (L)	mm	inch	960 ± 1.5	37.8	475 ± 1.5	18.7
Outer diameter module (D)	mm	inch	100	3.94	100	3.94
Inner diameter filtrate connection (d1)	mm	inch	28.4	1.12	28.4	1.12
Shipping weight (wet)	kg	lbs.	4.5	10	2.3	5

4" UF modules with Multibore® 1.5 membrane

Module data			dizzer® P 4040-4.0		dizzer® P 4021-1.8	
Part number			VK-0051		VK-0050	
Membrane area	m ²	sq.ft.	4.0	43	1.8	19.4
Length (L)	mm	inch	960 ± 1.5	37.8	475 ± 1.5	18.7
Outer diameter module (D)	mm	inch	100	3.94	100	3.94
Inner diameter filtrate connection (d1)	mm	inch	28.4	1.12	28.4	1.12
Shipping weight (wet)	kg	lbs.	4.5	10	2.3	5

2.5" UF modules with Multibore® 0.9 membrane

Module data			dizzer® P 2521-1.0		dizzer® P 2514-0.5	
Part number			VK-0047		VK-0046	
Membrane area	m ²	sq.ft.	1.0	11	0.5	5.4
Length (L)	mm	inch	475 ± 1.5	18.7	300 ± 1.5	11.8
Outer diameter module (D)	mm	inch	61	2.4	61	2.4
Inner diameter filtrate connection (d1)	mm	inch	17	0.67	17	0.67
Shipping weight (wet)	kg	lbs.	0.7	1.6	0.4	0.9

Modulkonstruktion		
Housing		PVC-U, white
Filtrate tube		PVC-U, white
Filtrate connectors		PVC-U, white

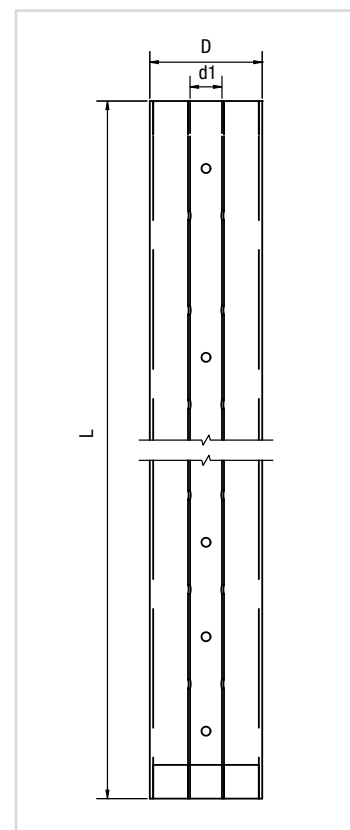

© = Registered trademark of BASF

Multibore® membranes

Multibore® 0.9 membrane

Membrane data			
Capillaries per fibre			7
Inside diameter of capillaries	mm		0.9
Pore size	µm		approx. 0.02
Burst pressure	bar	psi	>10 >150
Material			PESM
Mode of operation			In-to-Out-filtration

Multibore® 1.5 membrane

Membrane data			
Capillaries per fibre			7
Inside diameter of capillaries	mm		1.5
Pore size	µm		approx. 0.02
Burst pressure	bar	psi	>10 >150
Material			PESM
Mode of operation			In-to-Out-filtration

Technical information

Operating parameters	Multibore® 0.9 and 1.5 membrane			
Max. TMP filtration	bar	psi	3.0	43.5
Permissible temperature range*	°C	°F	1 - 40	34 - 104

Cleaning/disinfection chemicals		
NaClO (sodium hypochlorite)	ppm ppm x h	max. 500 max. 250,000 (at pH ≥ 9.5)
H ₂ O ₂ (hydrogen peroxide)	ppm	max. 500
Caustic Soda pH		max. 13
Acid pH		min. 1

* To avoid mechanical damage, do not subject the membrane module or element to sudden temperature changes (> 1°C/min) or water hammers.

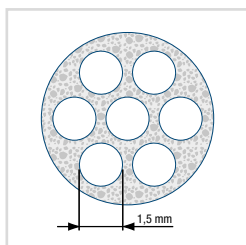
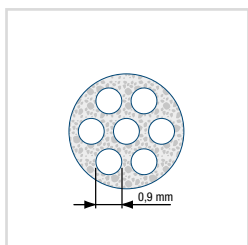

Module designation:

dizzer® P 4040-6.0

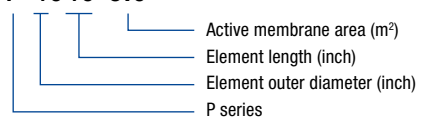

dizzer® P - Pressure housings

Pressure housings for 4" UF modules

Module data			PV 4040		PV 4021	
Part number			KT-0134		KT-0133	
Length (A)	mm	inch	1130	44.5	648	25.5
Distance connections (B)	mm	inch	1019	40.12	536	21.12
Outer diameter end cap (C)	mm	inch	159	6.25	159	6.25
Outer diameter shell (D)	mm	inch	114	4.5	114	4.5
Threaded connections (E)		inch		3/4" FNPT		3/4" FNPT

Pressure housings for 2.5" UF modules

Module data			PV 2521		PV 2514	
Part number			KT-0132		KT-0131	
Length (A)	mm	inch	603	23.75	425	16.75
Distance connections (B)	mm	inch	527	20.75	349	13.75
Outer diameter end cap (C)	mm	inch	95	3.75	95	3.75
Outer diameter shell (D)	mm	inch	73	2.88	73	2.88
Threaded connections (E)		inch		3/8" FNPT		3/8" FNPT



Technical information

Material						
Housing			PVC-U, white			
Filtrate end cap			Noryl GTX			
Operation parameters						
Maximum system pressure	bar	psi	10			145
Temperature range	°C	°F	1 – 40			34 – 104

Filtrate connectors for 2.5" and 4" UF modules

2.5" element filtrate connector kit	FC 25
Part number	EP-0052

4" element filtrate connector kit	FC 40
Part number	EP-0053

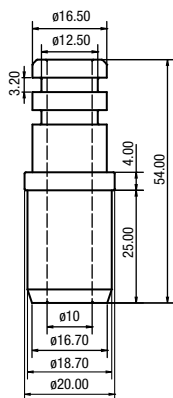

O-Ring: $\varnothing 12.37 \times 2.62$ (2 pieces per connector)
All dimensions in mm

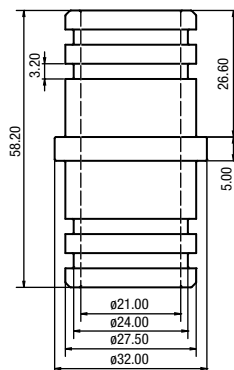

O-Ring: $\varnothing 23.81 \times 2.62$ (4 pieces per connector)
All dimensions in mm

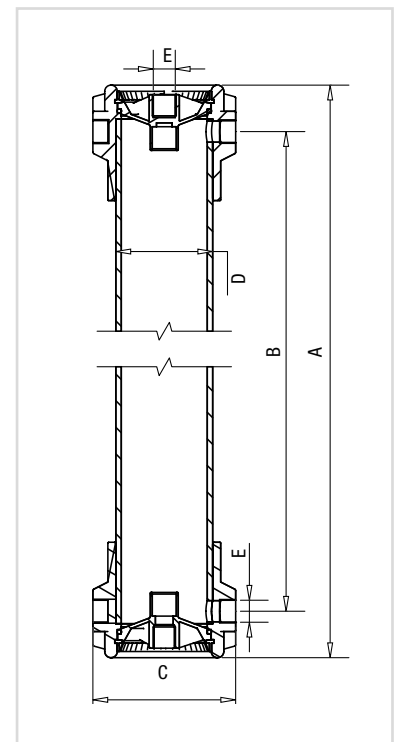

Note

The descriptions, designs, data and information („Product Information“) contained herein are presented in good faith and are based on inge GmbH's current knowledge and experience. inge GmbH cannot accept any liability for the accuracy of this Product Information, which is provided at no charge and for guidance only.

inge® products are designed to specifically be operated in accordance with the corresponding inge® „Operator's Manual“. The Product Information and products are protected by copyright and/or other intellectual property laws worldwide. However, inge GmbH cannot guarantee that the Product Information and products can be used without infringing third party intellectual property rights. The products and Product Information may only be used, distributed and marketed with the express prior permission of inge GmbH.

No warranties of any kind regarding the products, either expressed or implied, including, but not limited to, warranties of merchantability, fitness for a particular purpose or no third party rights are made, other than as expressly set out in the contractual agreement with the customer. Mechanical stability and full functionality of inge® products can only be provided by genuine inge® parts.

inge GmbH reserves the right to modify products and Product Information at any time without prior information. Current Product Information can be obtained from the website www.inge.basf.com

Technical Specifications d P 8.1(2017-02) E inge

inge GmbH
Flurstrasse 27
86926 Greifenberg, Germany
Phone +49 8192 997-700
Fax +49 8192 997-999
info@inge.ag

www.inge.basf.com

